



1500W Axial Leaded Transient Voltage Suppressors

DO-201AE

Features

- Peak power dissipation 1500W @10 x 1000 us Pulse
- Low profile package.
- Excellent clamping capability.
- Glass passivated junction.
- Fast response time: typically less than 1ps from 0 Volts to BV min
- Typical I_R less than 1uA when V_{BR} min above 12V.
- IEC 61000-4-2 ESD 30KV(Air), 30KV(Contact)
- ESD protection of data lines in accordance with IEC 61000-4-2
- EFT protection of data lines in accordance with IEC 61000-4-4
- RoHS compliant
- Lead-free finish

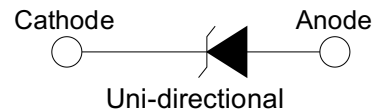
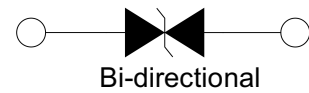
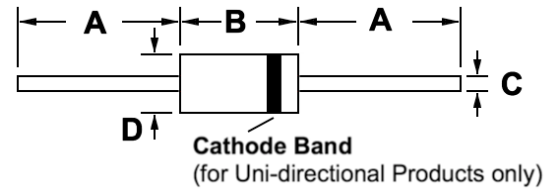

Mechanical Characteristics

- CASE: DO-201AE Molded Plastic
- Mounting Position: Any
- Polarity: by cathode band denotes uni-directional device, none cathode band denotes bi-directional device.
- Terminal: Solder plated

REF.	DIMENSIONS			
	Millimeters		Inches	
	Min.	Max.	Min.	Max.
A	25.4	---	1.000	---
B	6.73	9.53	0.265	0.375
C	0.94	1.07	0.037	0.042
D	4.78	5.33	0.188	0.210

Maximum Ratings and Characteristics @ 25°C Ambient Temperature (unless otherwise noted)

Parameter	Symbol	Value	Units
Peak Pulse Power Dissipation on 10/1000 us Waveform (Note 1, FIG.1)	P_{PPM}	Min 1500	W
Power Dissipation on Infinite Heat Sink at $T_L=75^\circ\text{C}$	P_D	6.5	W
Peak Pulse Current of on 10/1000us Waveform (Note 1, FIG.3)	I_{PPM}	See Table 1	A
Peak Forward Surge Current, 8.3ms Single Half Sine-Wave (Note 2)	I_{FSM}	200	A
Operating Junction Temperature Range	T_J	-55 to 150	$^\circ\text{C}$
Storage Temperature Range	T_{STG}	-55 to 150	$^\circ\text{C}$

Notes:

1. Non-repetitive current pulse, per Fig.3 and derated above $T_A=25^\circ\text{C}$ per Fig.2.
2. Measured on 8.3ms single half sine-wave, or equivalent square wave, for Unidirectional device only.

1.5KE Series

Electrical Specification (T_A=25@25°C unless otherwise specified)

Type Number		Reverse Stand-Off Voltage	Breakdown Voltage Min. @I _T	Breakdown Voltage Max. @ I _T	Test Current	Maximum Clamping Voltage @I _{PP}	Peak Pulse Current	Reverse Leakage @V _{RMW}
(Uni)	(Bi)	V _{RMW} (V)	V _{BR MIN} (V)	V _{BR MAX} (V)	I _T (mA)	V _C (V)	I _{PP} (A)	I _R (μA)
1.5KE6.8A	1.5KE6.8CA	5.80	6.45	7.14	10	10.5	144.8	1000
1.5KE7.5A	1.5KE7.5CA	6.40	7.13	7.88	10	11.3	134.5	500
1.5KE8.2A	1.5KE8.2CA	7.02	7.79	8.61	10	12.1	125.6	200
1.5KE9.1A	1.5KE9.1CA	7.78	8.65	9.55	1	13.4	113.4	50
1.5KE10A	1.5KE10CA	8.55	9.50	10.50	1	14.5	104.8	10
1.5KE11A	1.5KE11CA	9.40	10.50	11.60	1	15.6	97.4	5
1.5KE12A	1.5KE12CA	10.20	11.40	12.60	1	16.7	91.0	5
1.5KE13A	1.5KE13CA	11.10	12.40	13.70	1	18.2	83.5	1
1.5KE15A	1.5KE15CA	12.80	14.30	15.80	1	21.2	71.7	1
1.5KE16A	1.5KE16CA	13.60	15.20	16.80	1	22.5	67.6	1
1.5KE18A	1.5KE18CA	15.30	17.10	18.90	1	25.2	60.3	1
1.5KE20A	1.5KE20CA	17.10	19.00	21.00	1	27.7	54.9	1
1.5KE22A	1.5KE22CA	18.80	20.90	23.10	1	30.6	49.7	1
1.5KE24A	1.5KE24CA	20.50	22.80	25.20	1	33.2	45.8	1
1.5KE27A	1.5KE27CA	23.10	25.70	28.40	1	37.5	40.5	1
1.5KE30A	1.5KE30CA	25.60	28.50	31.50	1	41.4	36.7	1
1.5KE33A	1.5KE33CA	28.20	31.40	34.70	1	45.7	33.3	1
1.5KE36A	1.5KE36CA	30.80	34.20	37.80	1	49.9	30.5	1
1.5KE39A	1.5KE39CA	33.30	37.10	41.00	1	53.9	28.2	1
1.5KE43A	1.5KE43CA	36.80	40.90	45.20	1	59.3	25.6	1
1.5KE47A	1.5KE47CA	40.20	44.70	49.40	1	64.8	23.5	1
1.5KE51A	1.5KE51CA	43.60	48.50	53.60	1	70.1	21.7	1
1.5KE56A	1.5KE56CA	47.80	53.20	58.80	1	77.0	19.7	1
1.5KE62A	1.5KE62CA	53.00	58.90	65.10	1	85.0	17.9	1
1.5KE68A	1.5KE68CA	58.10	64.60	71.40	1	92.0	16.5	1
1.5KE75A	1.5KE75CA	64.10	71.30	78.80	1	103.0	14.8	1
1.5KE82A	1.5KE82CA	70.10	77.90	86.10	1	113.0	13.5	1
1.5KE91A	1.5KE91CA	77.80	86.50	95.50	1	125.0	12.2	1
1.5KE100A	1.5KE100CA	85.50	95.00	105.00	1	137.0	11.1	1
1.5KE110A	1.5KE110CA	94.00	105.00	116.00	1	152.0	10.0	1
1.5KE120A	1.5KE120CA	102.00	114.00	126.00	1	165.0	9.2	1
1.5KE130A	1.5KE130CA	111.00	124.00	137.00	1	179.0	8.5	1
1.5KE150A	1.5KE150CA	128.00	143.00	158.00	1	207.0	7.3	1
1.5KE160A	1.5KE160CA	136.00	152.00	168.00	1	219.0	6.9	1
1.5KE170A	1.5KE170CA	145.00	162.00	179.00	1	234.0	6.5	1
1.5KE180A	1.5KE180CA	154.00	171.00	189.00	1	246.0	6.2	1

※ For Bi-directional type having V_{RMW} of 10 Volts and less, the I_R limit is double.

※ For parts without A, the V_{BR} is ± 10% and V_C is 5% higher than with A parts.

1.5KE Series

Type Number		Reverse Stand-Off Voltage	Breakdown Voltage Min. @ I_T	Breakdown Voltage Max. @ I_T	Test Current	Maximum Clamping Voltage @ I_{PP}	Peak Pulse Current	Reverse Leakage @ V_{RWM}
(Uni)	(Bi)	$V_{RWM}(V)$	$V_{BR MIN}(V)$	$V_{BR MAX}(V)$	$I_T (mA)$	$V_C(V)$	$I_{PP}(A)$	$I_R(\mu A)$
1.5KE200A	1.5KE200CA	171.00	190.00	210.00	1	274.0	5.5	1
1.5KE220A	1.5KE220CA	185.00	209.00	231.00	1	328.0	4.6	1
1.5KE250A	1.5KE250CA	214.00	237.00	263.00	1	344.0	4.4	1
1.5KE300A	1.5KE300CA	256.00	285.00	315.00	1	414.0	3.7	1
1.5KE350A	1.5KE350CA	300.00	332.00	368.00	1	482.0	3.2	1
1.5KE400A	1.5KE400CA	342.00	380.00	420.00	1	548.0	2.8	1
1.5KE440A	1.5KE440CA	376.00	418.00	462.00	1	602.0	2.5	1
1.5KE480A	1.5KE480CA	408.00	456.00	504.00	1	658.0	2.3	1
1.5KE510A	1.5KE510CA	434.00	485.00	535.00	1	698.0	2.2	1
1.5KE530A	1.5KE530CA	451.00	503.50	556.50	1	725.0	2.1	1
1.5KE540A	1.5KE540CA	460.00	513.00	567.00	1	740.0	2.1	1
1.5KE550A	1.5KE550CA	468.00	522.50	577.50	1	760.0	2.0	1
1.5KE600A	1.5KE600CA	512.00	570.00	630.00	1	828.0	1.8	1

※ For Bi-directional type having V_{RWM} of 10 Volts and less, the I_R limit is double.

※ For parts without A, the V_{BR} is $\pm 10\%$ and V_C is 5% higher than with A parts.

I-V Curve Characteristics

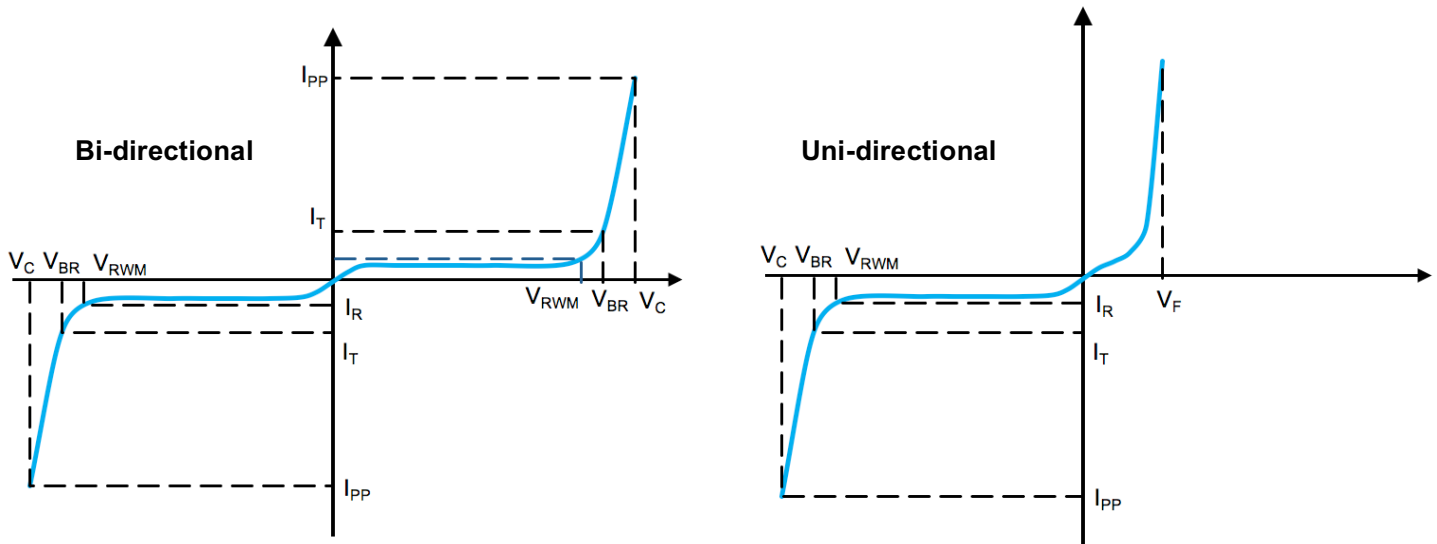

P_{PPM} **Peak Pulse Power Dissipation** - Max power dissipation

V_{RWM} **Reverse Stand-off Voltage** - Maximum voltage that can be applied to TVS without operation

V_{BR} **Breakdown Voltage** – Maximum voltage that flows through the TVS at a specified current (I_T)

V_C **Clamping Voltage** – Peak voltage measured across the TVS at a specified I_{PPM} (peak impulse current)

I_R **Reverse Leakage Current** – Current measured at V_R

V_F **Forward Voltage Drop for Uni-directional**

Ratings and Characteristic Curves ($T_A=25^\circ\text{C}$ unless otherwise noted)

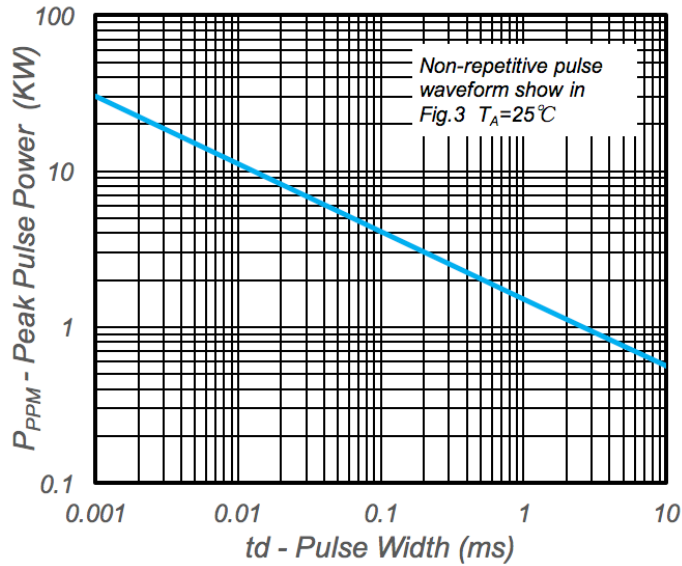

Fig.1 - Peak Pulse Power Rating

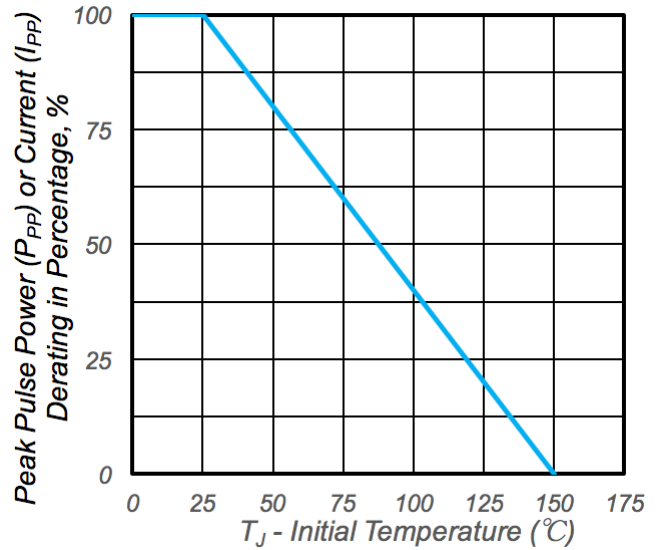

Fig.2 - Pulse Derating Curve

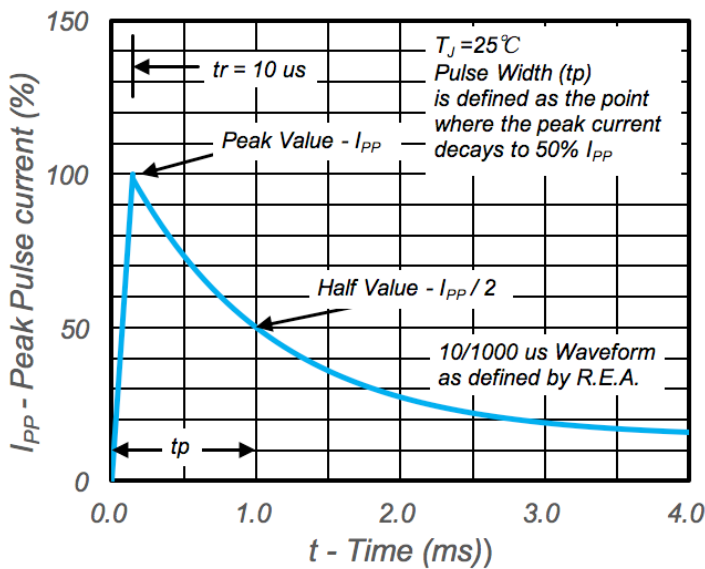

Fig.3 - Pulse Waveform

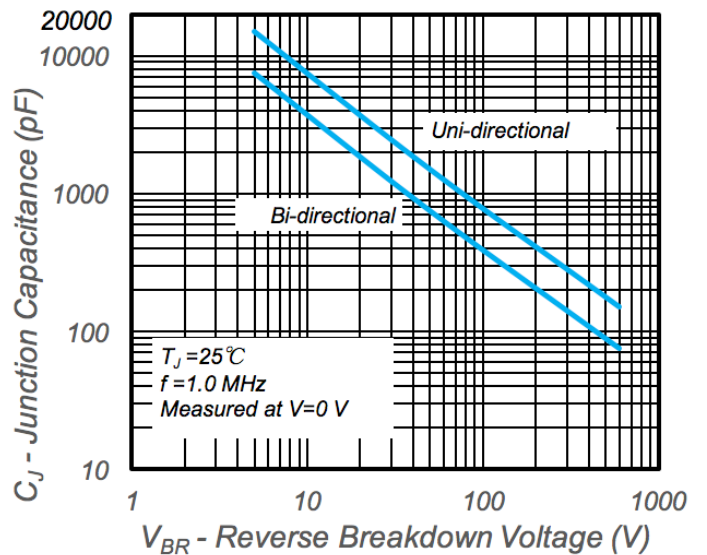

Fig.4 - Typical Junction Capacitance